

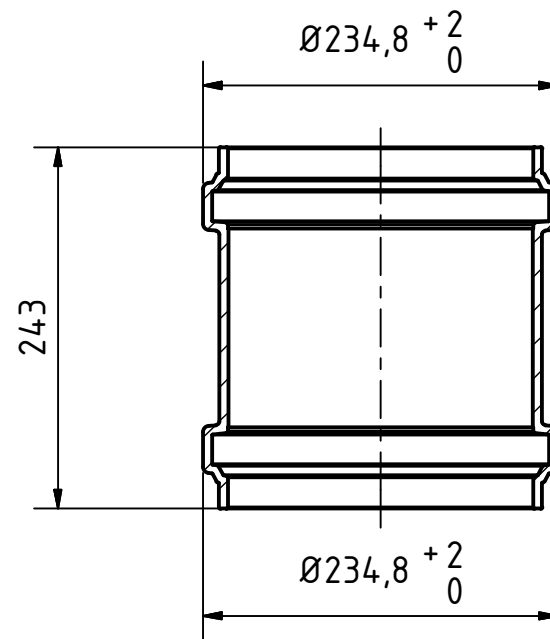

A-A ( 1 : 5 )



|  |            |                      |      |                 |            |  |  |
|--|------------|----------------------|------|-----------------|------------|--|--|
|   |            | Maße nach Z-42.1-217 |      | Art.Nr.: 338500 |            | Maßstab 1:5  |  |
|  |            |                      |      | Material: PP-MD |            |  |  |
|  |            |                      |      | Datum           | Name       |  |  |
|  |            |                      |      | Gezeichnet      | 08.01.2018 | A.Schmedes   |  |
|  |            |                      |      | Kontroll.       |            |  |  |
| Status   | Änderungen | Datum                | Name | Norm            |            |  |  |
| Gebr. Ostendorf Kunststoffe GmbH<br>Rudolf-Diesel-Str. 6-8<br>D-49377 Vechta<br>verkauf@ostendorf-kunststoffe.com<br>www.ostendorf-kunststoffe.com |            |                      |      |                 |            | <h1>Skolan Safe</h1>   |  |
|  |            |                      |      |                 |            |  |  |
|  |            |                      |      |                 |            | <div style="border: 1px solid black; padding: 2px; display: inline-block;">1</div><br>A3 |  |
| Schutzvermerk nach DIN ISO 16016 beachten!   |            |                      |      |                 |            |  |  |