

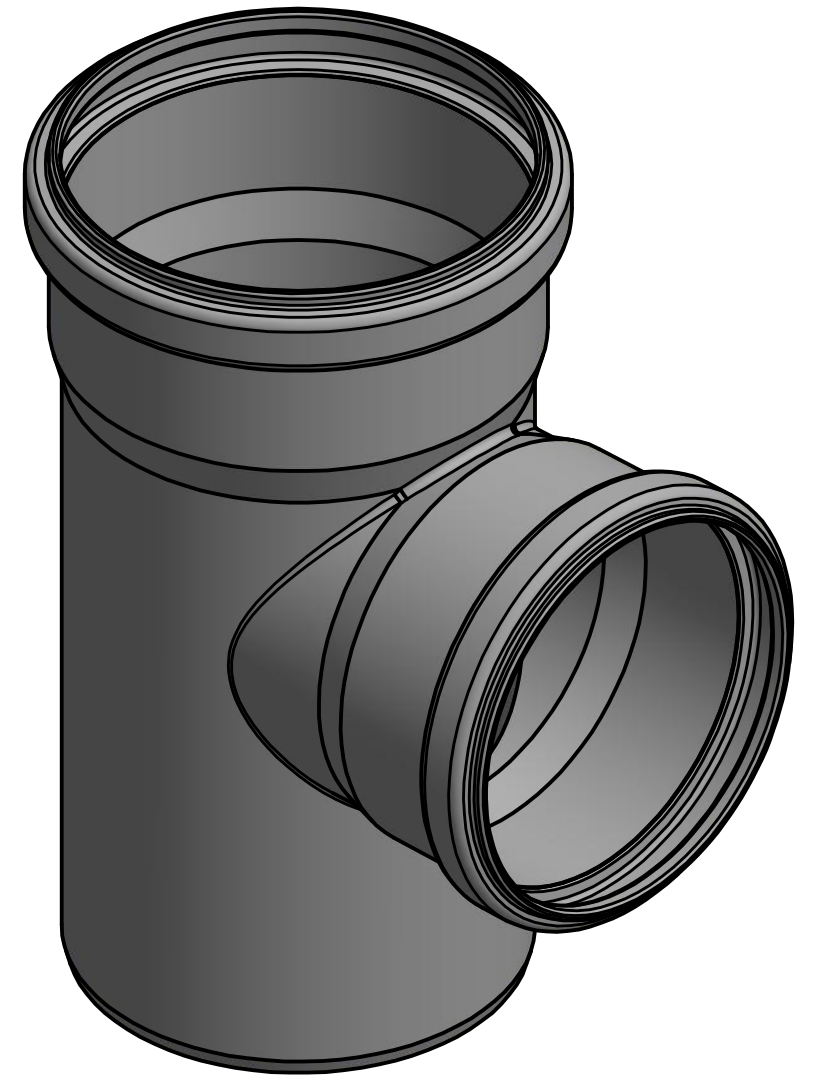

A-A (1 : 2)

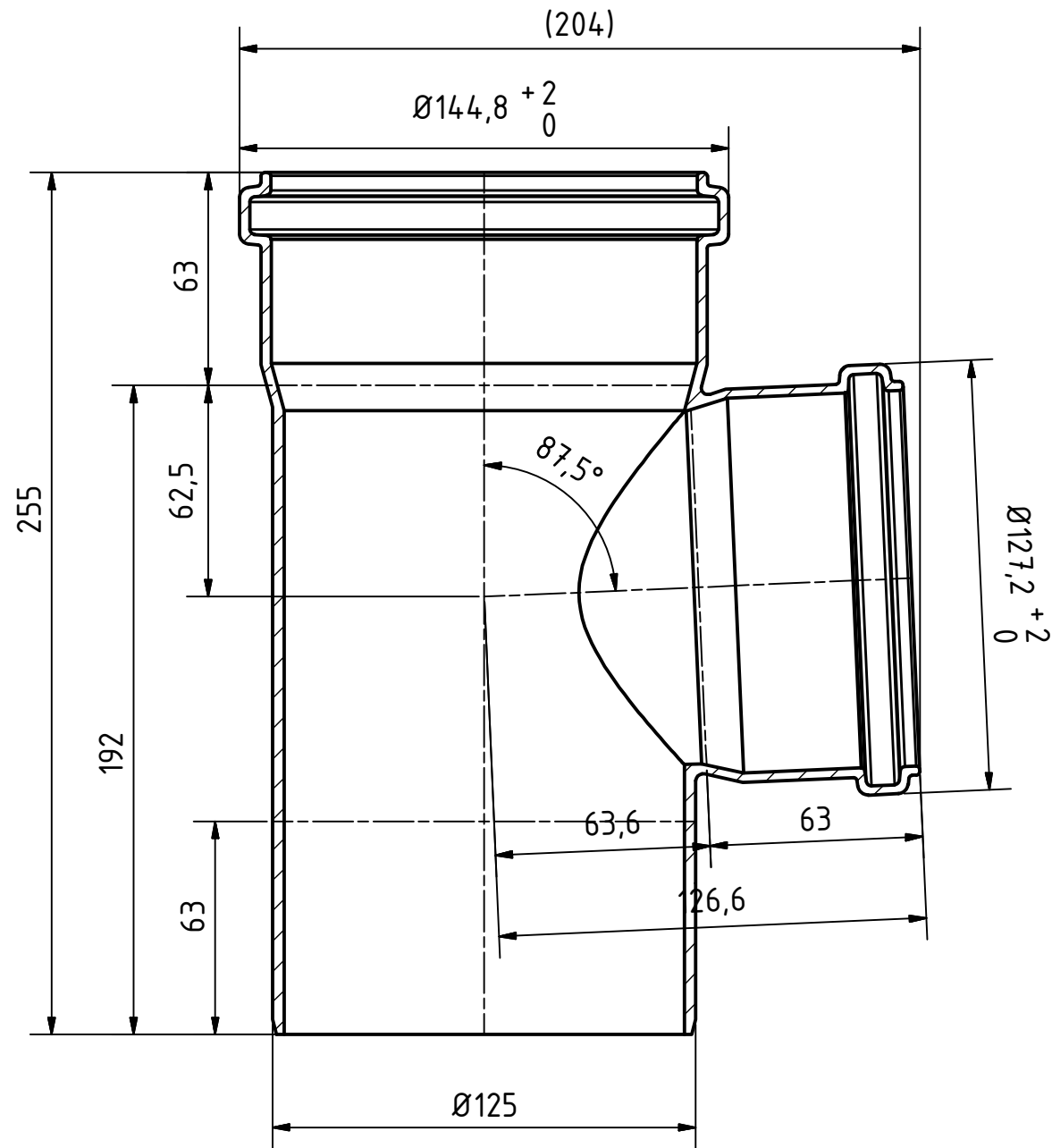
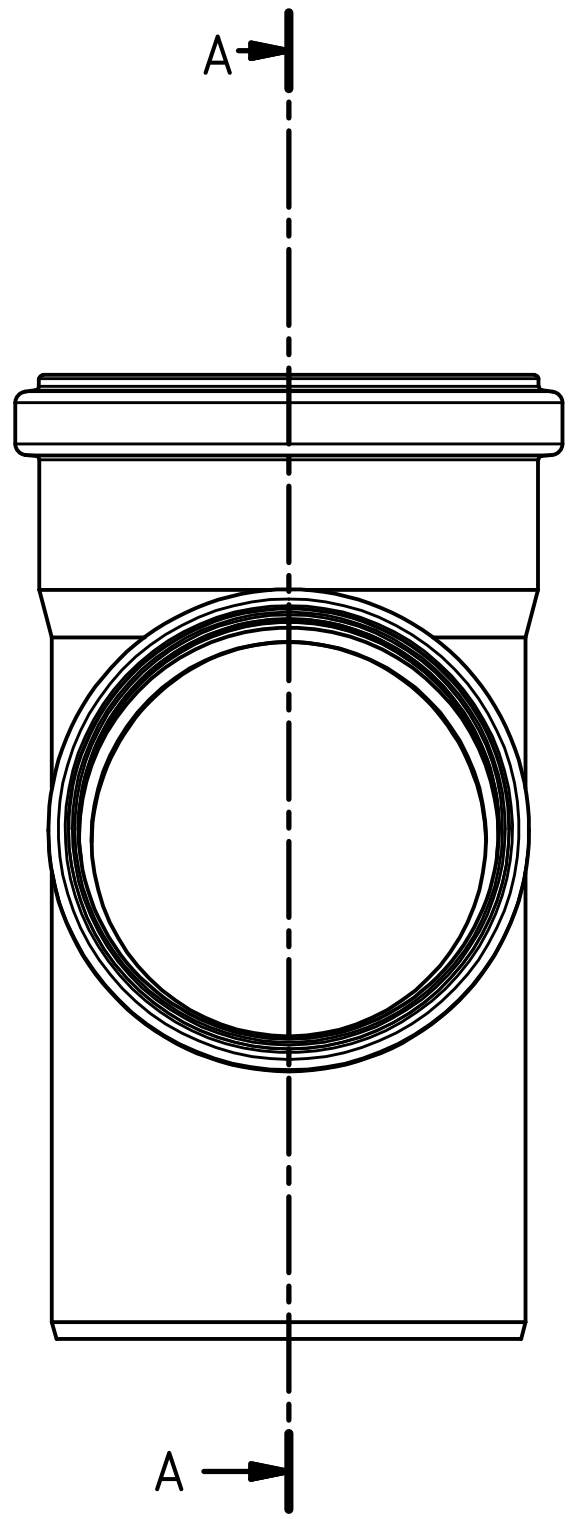

| | | | | | | | |
|--|------------|----------------------------|------|----------------------------------|--|------------------------------------|--|
|  | | Maße nach DIN EN 1451-1 | | Art.Nr.: 176410 | | Maßstab 1:2 | |
| | | | | Material: PP-H schwerentflammbar | | | |
| | | Datum | | Name | | <h1>HT Safe</h1> | |
| | | Gezeichnet | | A.Schmedes | | | |
| | | Kontroll. | | | | | |
| Status | Änderungen | Datum | Name | Norm | | | |
| Gebr. Ostendorf Kunststoffe GmbH Rudolf-Diesel-Str. 6-8 D-49377 Vechta verkauf@ostendorf-kunststoffe.com www.ostendorf-kunststoffe.com | | | | | | HTsafeEA Abzweig DN/OD 125/110/87° | |
| | | | | | | 1 | |
| | | | | | | A3 | |
| Schutzvermerk nach DIN ISO 16016 beachten! | | | | | | | |