

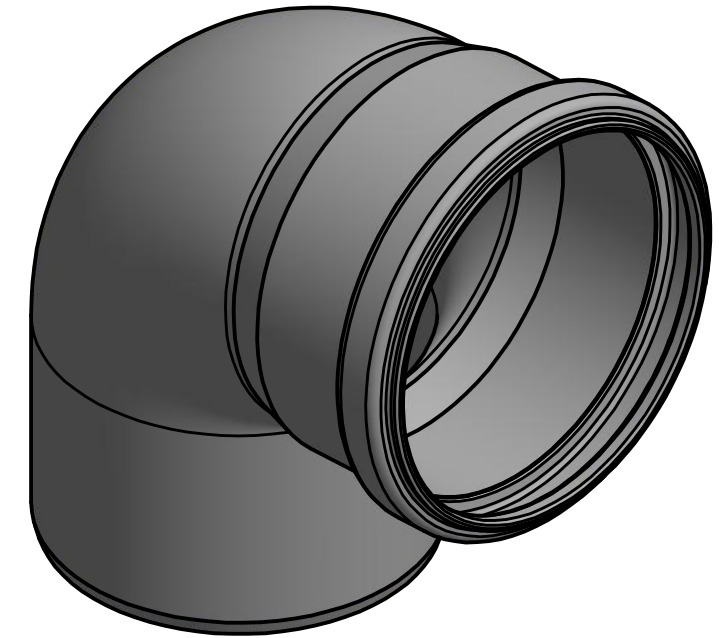

A-A ( 1 : 2 )

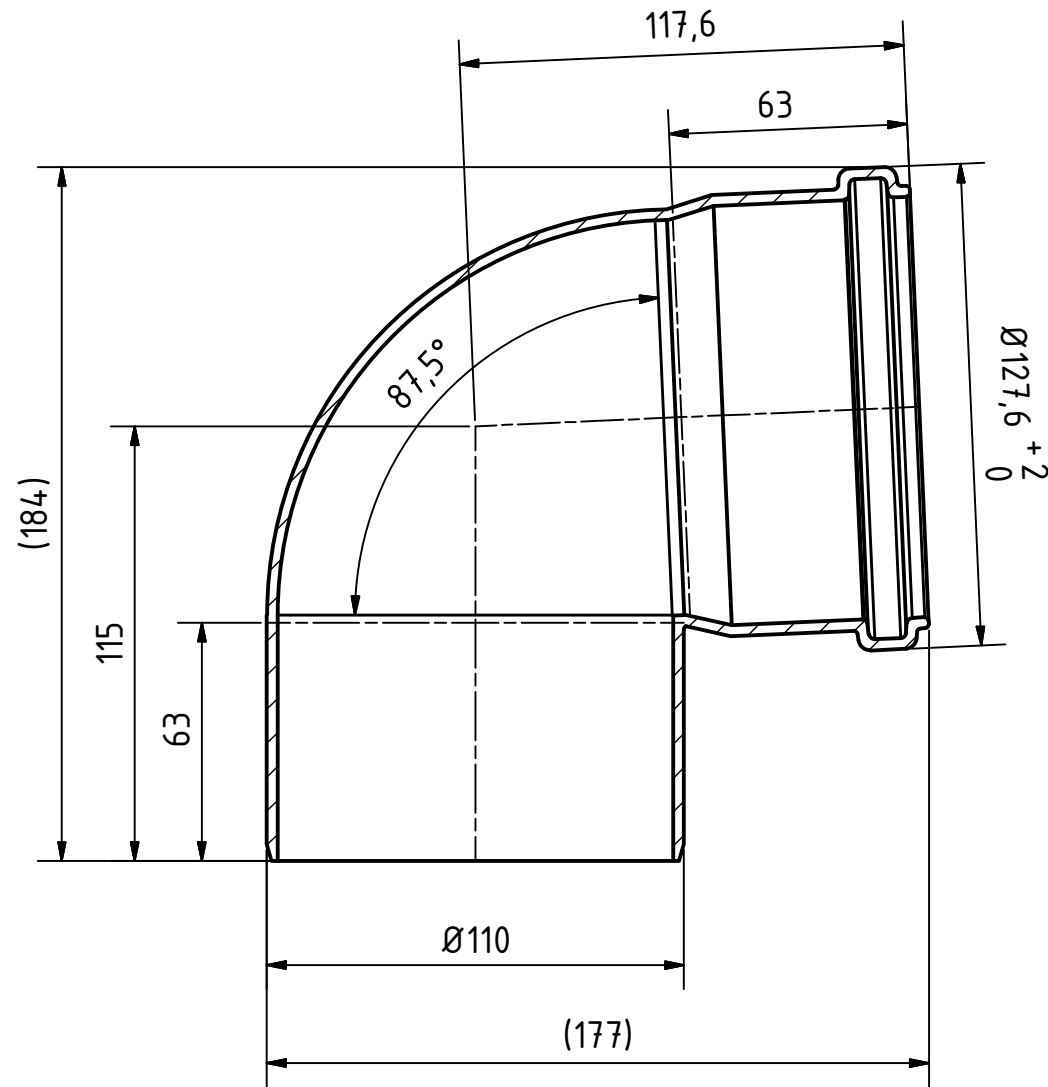

		Maße nach		Art.Nr.: 175140		Maßstab 1:2		
		DIN EN 1451-1		Material: PP-H schwerentflammbar				
			Datum	Name		<h1>HT Safe</h1>		
			Gezeichnet	30.09.2016	A.Schmedes			
			Kontroll.					
Status	Änderungen	Datum	Name	Norm				
Gebr. Ostendorf Kunststoffe GmbH Rudolf-Diesel-Str. 6-8 D-49377 Vechta verkauf@ostendorf-kunststoffe.com www.ostendorf-kunststoffe.com						HTsafeB Bogen DN/OD 110/87°		
						1 A3		
						Schutzvermerk nach DIN ISO 16016 beachten!		